

TOP VIEW

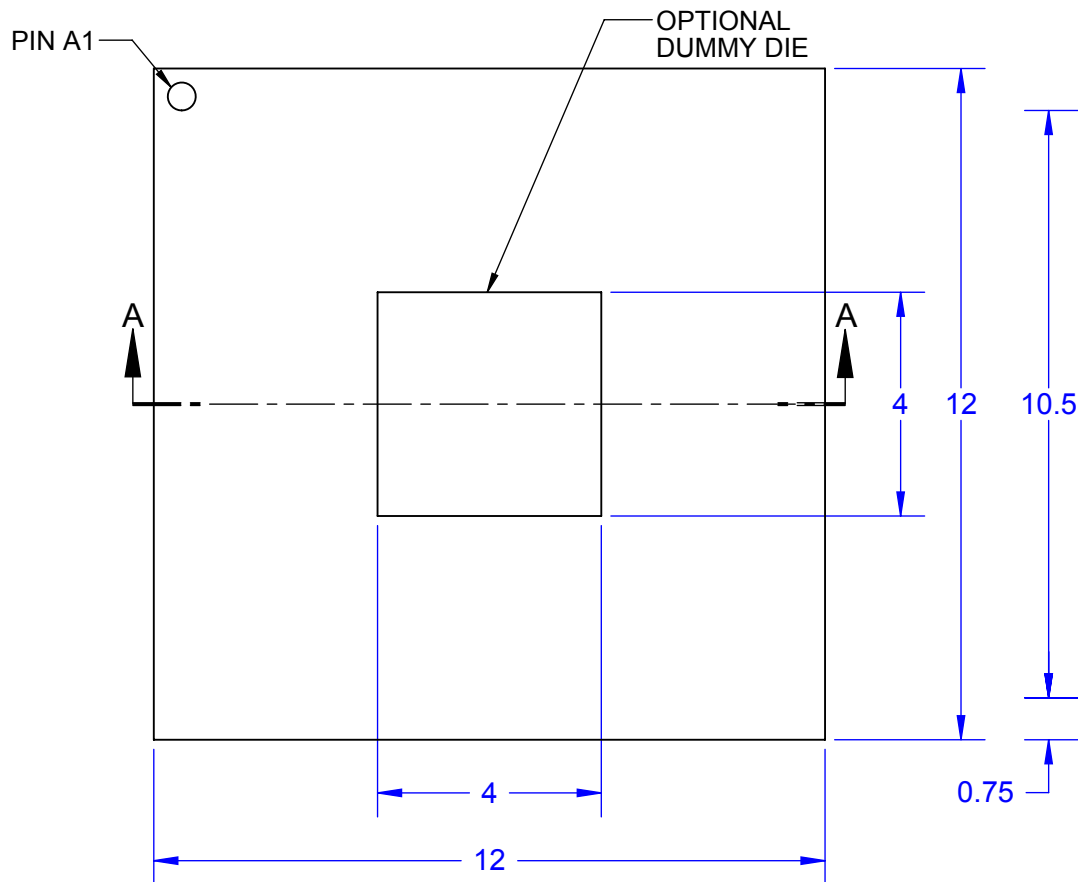

BALL VIEW

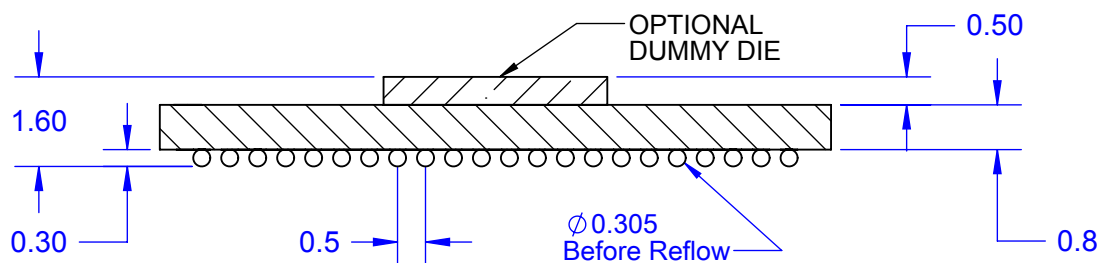
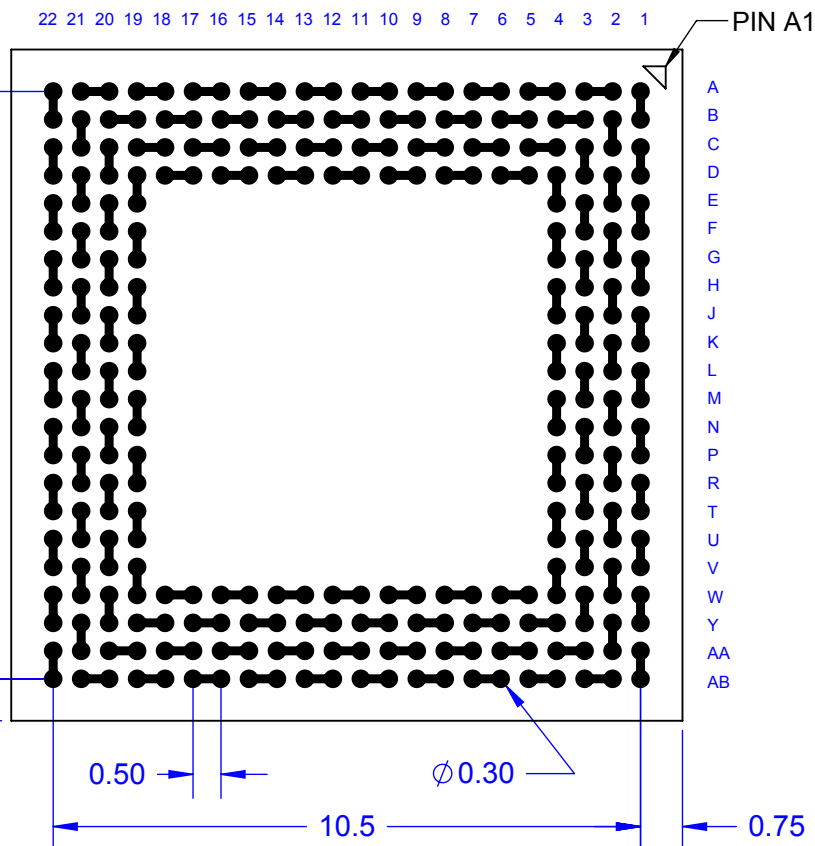

SECTION A-A

PART NUMBER TABLE

PART NUMBER	BALL ALLOY	Pb-Free	RoHS	Si DIE
LBGA288T.5C-DC221B	Sn96.5/Ag3.0/Cu0.5	YES	YES	NO
LBGA288T.5C-DC221BD	Sn96.5/Ag3.0/Cu0.5	YES	YES	YES
LBGA288T.5-DC221B	Sn63/Pb37	NO	NO	NO
LBGA288T.5-DC221BD	Sn63/Pb37	NO	NO	YES

Notes: (Unless Otherwise Specified).

- 1) ALL DIMENSIONS ARE IN MM.
- 2) SOLDER BALL ALLOY: SEE PART NUMBER TABLE.
- 3) BALL DIAMETER (BEFORE REFLOW): 0.30mm.
- 4) SOLDER MASK DEFINED PAD OPENING: 0.28mm (11 MIL).
- 5) PAD Cu DIAMETER: 0.355mm (14 MIL).
- 6) SUBSTRATE MATERIAL: BT (ALTERNATE FR4).
- 7) DUMMY DIE IS OPTIONAL.
- 8) DAISY CHAIN PATTERN (SEE PAGE 2).
- 9) MSL-3 RECOMMENDED BAKING 24 HOURS @ 125°C TO REMOVE MOISTURE PRIOR SOLDERING TO PC BOARD.

APPROVALS	DATE				
DRAWN T.Au	12/27/13				
ENG M. Hart	12/27/13	TITLE		LBGA288T.5-DC221B DAISY CHAIN DUMMY	
MFG		SCALE	SIZE	DRAWING NO.	REV
QA		7.5:1	A	552210	A
CUST		DO NOT SCALE DRAWING			SHEET 1 OF 2
REVISED					

BALL VIEW

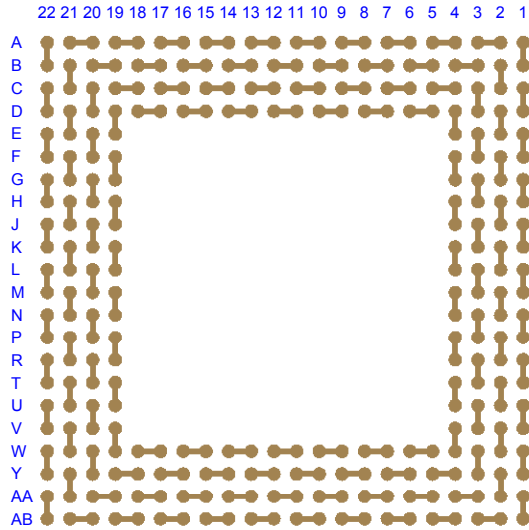

BOTTOM SIDE (TOP X-RAY VIEW)

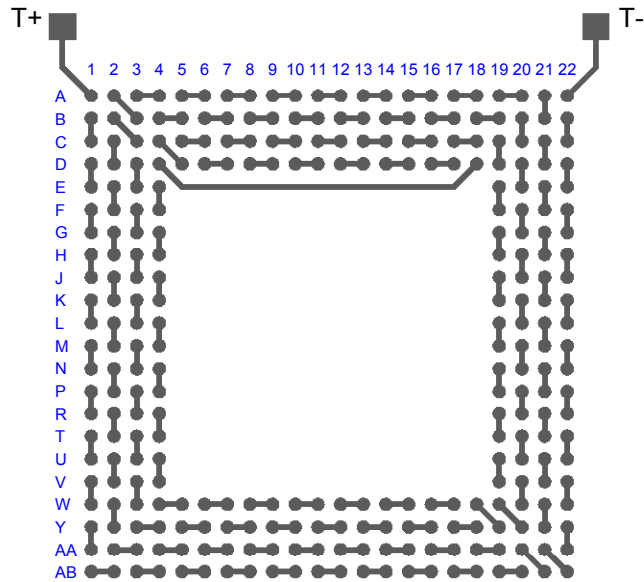
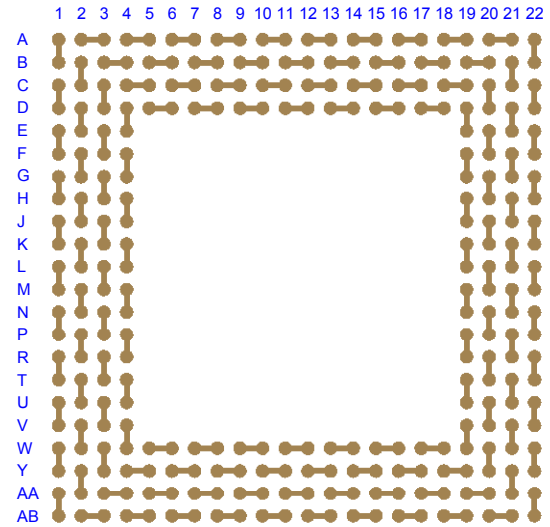

TEST VEHICLE BOARD

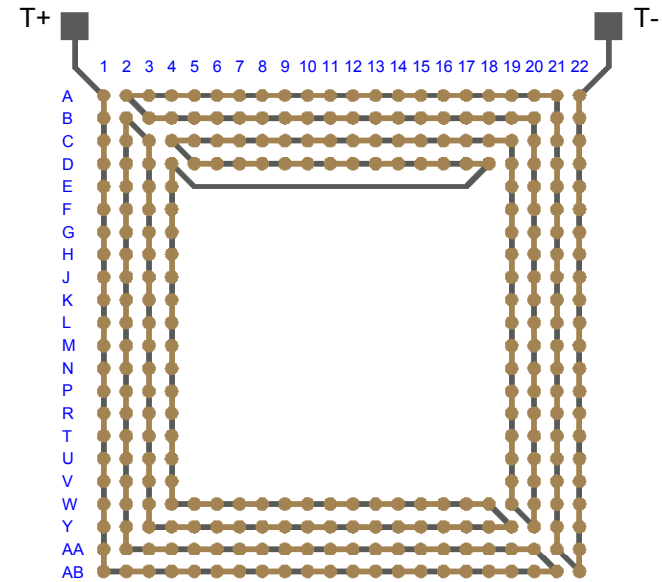

AFTER MOUNTING

Notes:

- 1) PCB BOARD DIMENSIONS ARE PRESENTED ONLY AS A GUIDELINE. DESIGNERS SHOULD USE THEIR OWN EXPERIENCE WHEN DESIGNING PCB.
- 2) PCB Cu BALL PAD DIAMETER 0.355mm (14 MIL).
- 3) PCB DAISY CHAIN TRACING LINE WIDTH 0.127mm (5 MIL).
- 4) SMD (SOLDER MASK DEFINED) PAD OPENING: 0.28mm (11 MIL).

TopLine®			
TITLE		LBGA288T.5-DC221B DAISY CHAIN DUMMY	
SCALE	SIZE	DRAWING NO.	REV
6:1	A	552210	A
DO NOT SCALE DRAWING			SHEET 2 OF 2